

REV
NC **WB-48P***

REVISIONS			
SYM	DESCRIPTION	DATE	APPROVED
NC	NEW RELEASE PER E.O. P17165	3-7-01	RDR

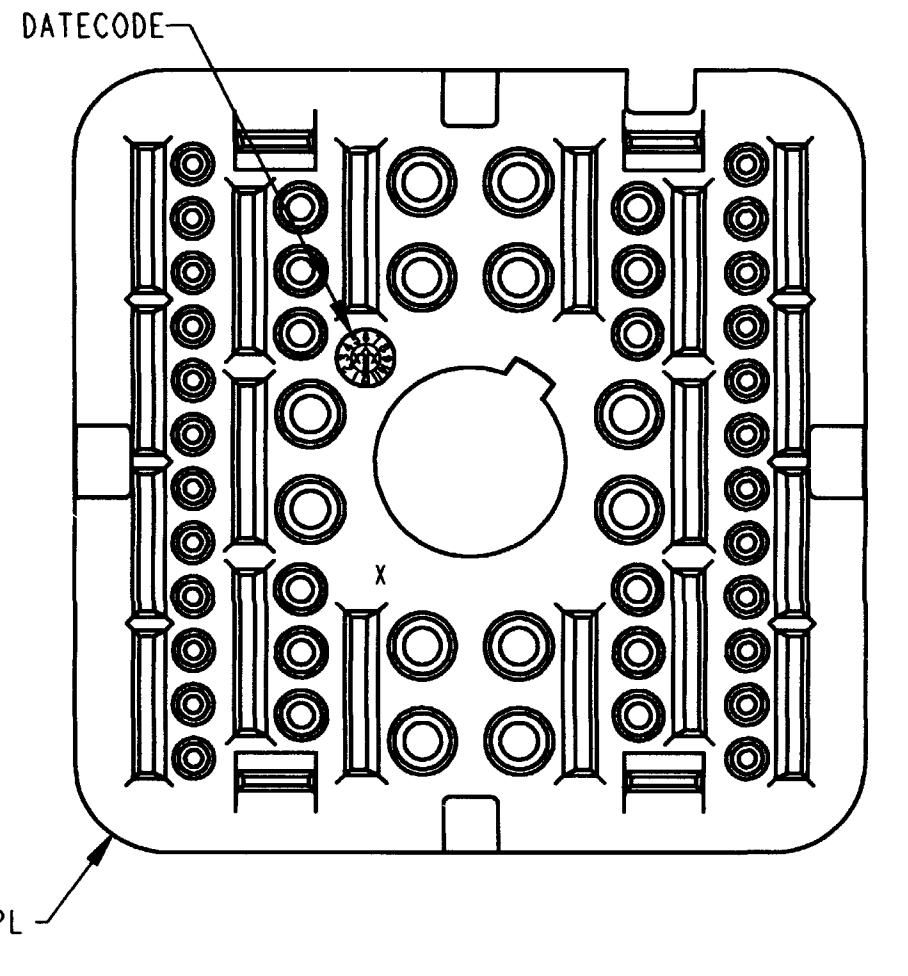

- NOTES:
1. DIMENSIONS ARE IN INCHES [mm].
 2. DIMENSION TOLERANCE: $\pm .025$ [.64].
 3. THIS WEDGE LOCK MATES WITH DRB12-48P*(N)E-**** RECEPTACLE. (* = A,B,C,D KEYS; **** = ALL MODIFICATIONS). CONSULT FACTORY FOR MODS.
 4. MATERIAL: PLASTIC
 5. SEE SHEET 2 FOR OTHER KEY ARRANGEMENTS.

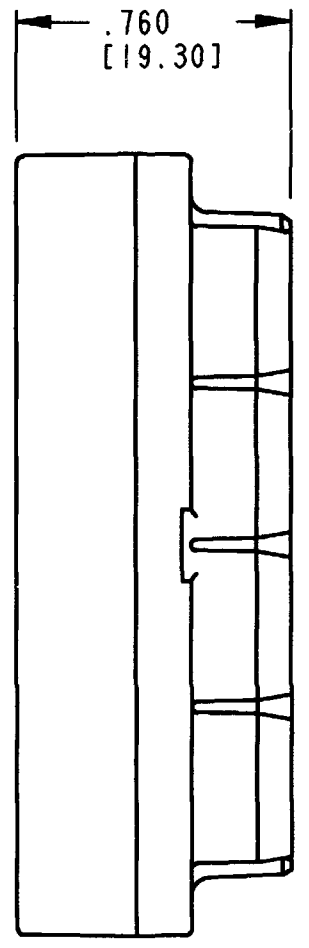
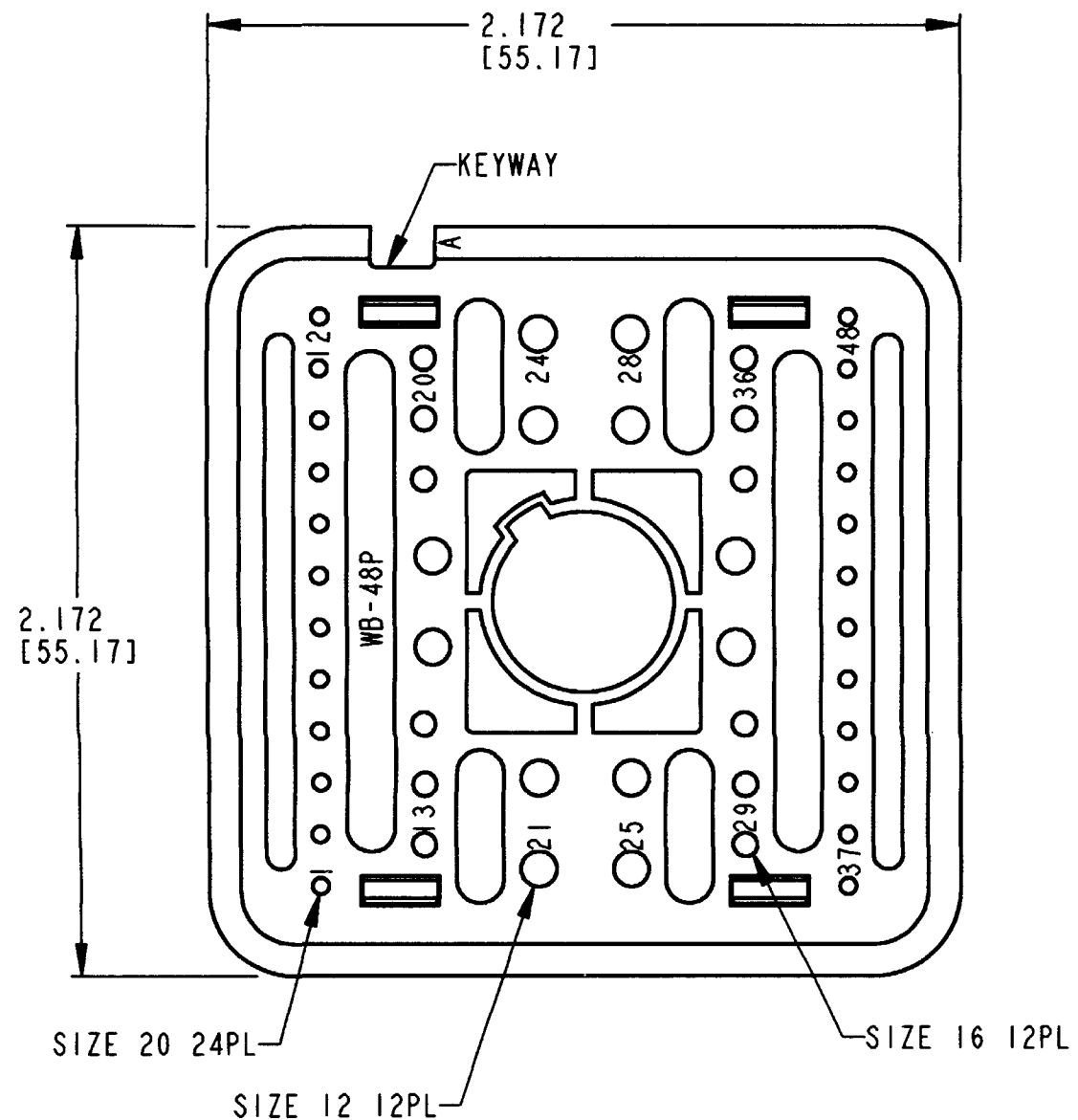
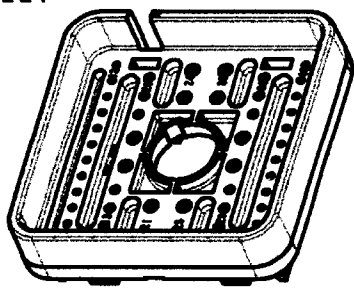

SIGNATURE & DATE	
DR	S. PALLUTH 02/28/01
CHK	<i>[Signature]</i> 3/6/01
PE	<i>[Signature]</i> 3/1/01
APPD	<i>[Signature]</i> 3/1/01
SCALE	NONE

WEDGE LOCK, RECEPTACLE
48 CONTACTS
KEY ARRANGEMENTS
A, B, C, & D
DRB SERIES
ENVELOPE

CP	EP063	MATL. CODE
The Deutsch Company DEUTSCH I.P.D. 3850 INDUSTRIAL AVE. HEMET, CALIF. 92545		
B	WB-48P*	
DWG SIZE	CODE 11139	SHEET 1 OF 2

REV	WB-48P*	REVISIONS			
NC		SYM	DESCRIPTION	DATE	APPROVED
			SEE SHEET 1	3-7-01	RDR

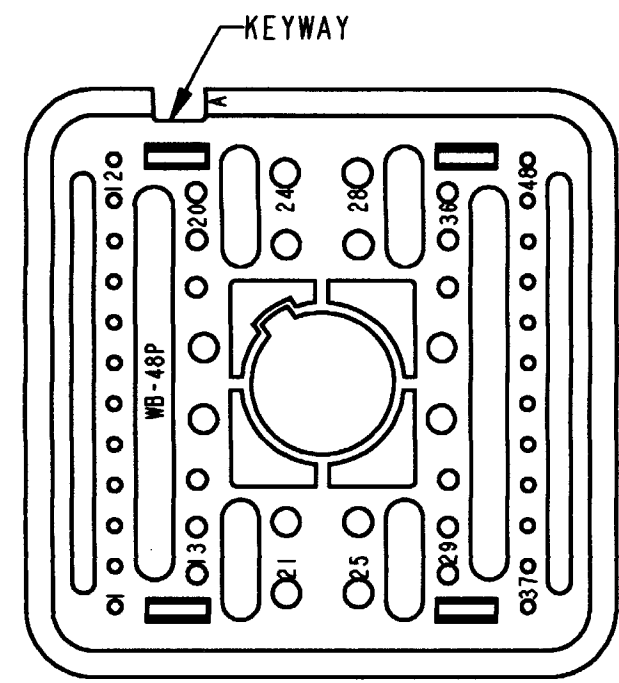

WB-48PA
KEY ARRANGEMENT -A-
COLOR: GREY

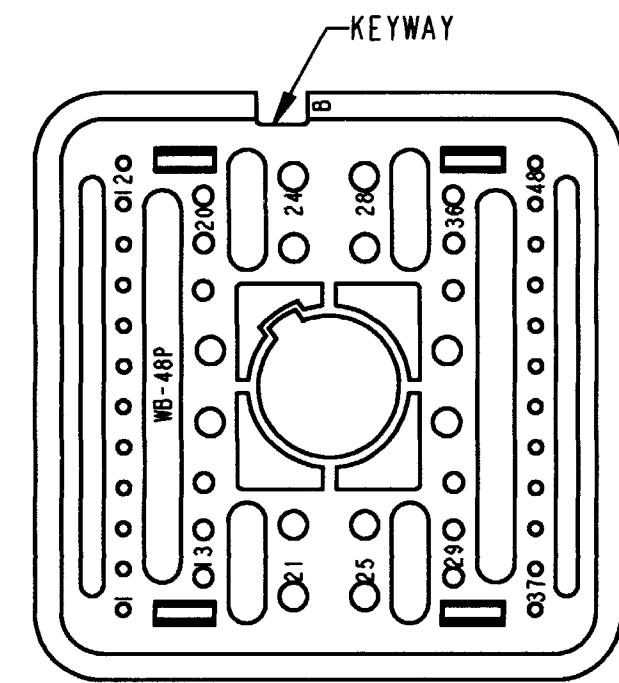

WB-48PB
KEY ARRANGEMENT -B-
COLOR: BLACK

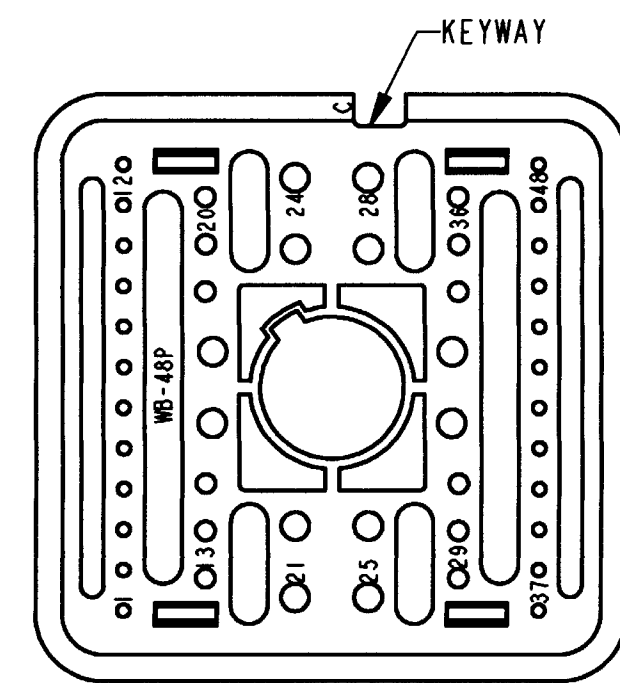

WB-48PC
KEY ARRANGEMENT -C-
COLOR: GREEN

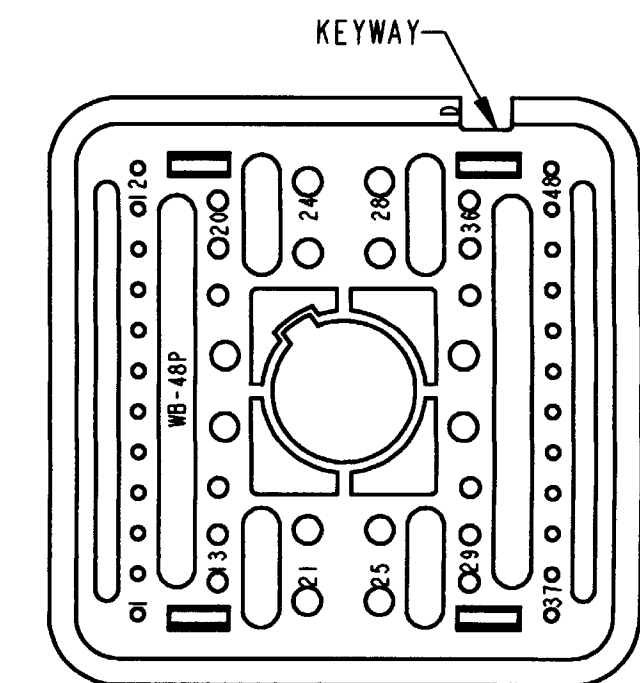

WB-48PD
KEY ARRANGEMENT -D-
COLOR: BROWN

NOTES:

	SIGNATURE & DATE	WEDGE LOCK, RECEPTACLE 48 CONTACTS KEY ARRANGEMENTS A, B, C, & D DRB SERIES ENVELOPE	CP	EP063	MATL. CODE
DR	S. PALLUTH 02/28/01		 The Deutsch Company DEUTSCH I.P.D. 3850 INDUSTRIAL AVE. HEMET, CALIF. 92545		
CHK	A. Blum 3/6/01				
PE	J. Palluth 3/1/01				
APPD	C. Meyer 3/1/01				
SCALE	NONE		B	WB-48P*	DWG. SIZE
					CODE 11139 SHEET 2 OF 2